

Micro-lenses for IR Sensor Applications

Your Application

- Collimation of emitters
- Focusing onto receivers

in Automotive, Metrology, Medical, Surveillance etc.

Our Solutions

- Micro-lenses in Silicon ($\lambda = 1-14\mu\text{m}$) and Fused Silica ($\lambda = 0.2-5\mu\text{m}$)
- Single lenses and 1D/2D arrays
- Aspherical or spherical profiles
- Metallization for soldering, light blocking etc.
- Optimized custom design

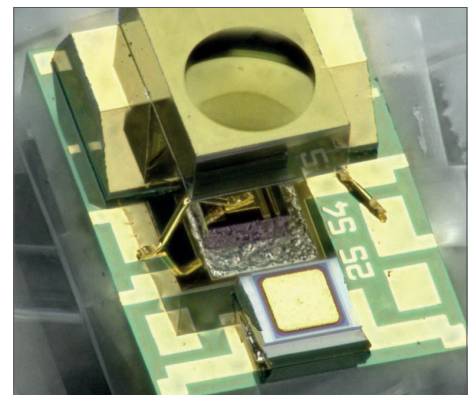

Courtesy EZconn Czech a.s.

Your Advantages

- Precise lens profile and pitch control
- High surface quality
- Ultra compact size for high integration
- Cost effective wafer level manufacturing

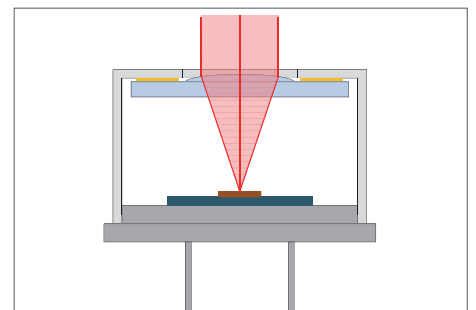

Example: lenses for TO-cans

Lens with optional solder pad

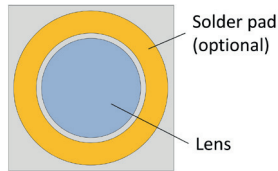

Lens mounted into TO-cap

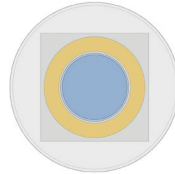

Hermetical TO-lens package

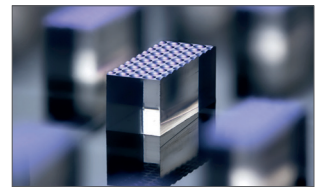
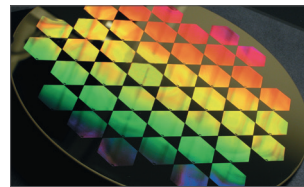
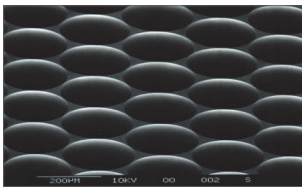
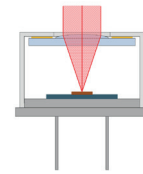

About Axetris AG

Axetris AG, a company of the Leister group, is serving OEM customers with micro-optical components used in telecom and industrial applications, and micro-technology based (MEMS) infrared light sources, laser gas sensors, mass flow sensors and controllers.

Axetris supports its customers in many industries with in-depth application know-how. Our engineering and manufacturing teams combine broad experience in simulation, design, manufacturing and metrology from microchip level to advanced electronic and electro-optic modules.

Customers benefit from excellent product value, consistent high product quality and outstanding customer support. OEMs rely on Axetris as a competent partner for a wide range of high-quality off-the shelf products as well as customer specific solutions from concept to volume production.

Axetris is ISO 9001 certified and ISO TS 16949 compliant and operates its own 6" to 8" wafer MEMS foundry in Central Switzerland for its own products and external customers.



Contact

Headquarters

Axetris AG, Switzerland

Schwarzenbergstrasse 10
CH-6056 Kaegiswil
Switzerland
phone +41 41 662 76 76
axetris@axetris.com
www.axetris.com

USA

Leister Technologies LLC

1275 Hamilton Parkway
Itasca, IL 60143
USA
phone +1 844 293 8747
axetris.usa@axetris.com
www.axetris.com

China

Leister Technologies Ltd.

Building 11, 155 Yuanke Road
Shanghai 201 109
China
phone +86 21 6442 2398
axetris@axetris.cn
www.axetris.cn

Japan

Leister Technologies KK

Shinyokohama Bousei Bldg 1F
3-20-12, Shinyokohama, Kohoku-ku
Yokohama 222-0033 / Japan
phone +81 45 447 36 37
axetris@axetris.jp
www.axetris.jp

Swiss Made Quality. Axetris is an ISO 9001 certified enterprise.